

让世界的包装因揽德更美好

Make the world's packaging be better because LANDPACK

LANDPACK

揽德包装机械

HORIZONTAL PACKING MACHINE CATALOG

枕式机画册



中文官网



English Web

佛山市揽德包装机械有限公司

FOSHAN LAND PACKAGING MACHINERY CO.,LTD

地址：广东省佛山市南海区狮山镇下柏第一工业区吉祥路8号智慧科技产业园

Add: Zhaheng Technology Industrial Park, No. 8 Jixiang Road, Xiabei First Industrial Zone,
Shishan Town, Nanhai District, Foshan, Guangdong, China

Tel: 0757-81807872 Fax: 0757-81807753

网址: www.landpack.cn Web: www.landpack.com

E-mail: yang@landpacking.com



佛山市揽德包装机械有限公司

FOSHAN LAND PACKAGING MACHINERY CO.,LTD



About LandPack

关于揽德

Foshan Land Packaging Machinery Co., Ltd. is located in Foshan, Guangdong Province, within a one-hour drive from Guangzhou Airport and just 20 minutes from Foshan High-Speed Railway Station. Established in 2017, the company is a high-tech enterprise integrating R&D, manufacturing, sales, and service. With a modern factory covering 30,000 square meters, Landpack is equipped with a team of senior engineers, installation and commissioning technicians, and marketing & after-sales service professionals. With over 130 employees, we provide customers with professional products and reliable service support.

Since its establishment, Landpack has been dedicated to the R&D and manufacturing of vertical form fill seal machines, filling machines, premade pouch packaging machines, multi lane packaging machines, flow pack machines, and feeding and packaging lines. Our products are widely applied in industries such as snacks food and health supplements, pet food, daily chemical products, fresh produce, sauces, and powders, offering customized and complete packaging solutions for enterprises.

Our products have obtained lots of national patent certificates, ISO9001 Quality Management System certification, as well as CE, TUV, SGS, and FDA approvals. They are exported to more than 100 countries and regions worldwide, receiving wide recognition and praise from customers.

At Landpack, we are committed to continuously refining and optimizing our products to deliver intelligent packaging equipment that is efficient, stable, safe, and beautiful packaging—striving to go beyond expectations and make the world a better place with Landpack Packaging.

佛山市揽德包装机械有限公司坐落于广东省佛山市，位于广州机场一小时，佛山动车站二十分钟交通圈。公司成立于2017年，是一家集研发、制造、销售及服务于一体的高新技术企业，配备三万平米现代化厂房，拥有骨干工程师，安装调试技术员团队和营销与售后技术服务团队，员工规模达130人，为客户提供专业的产品和服务保障。

我司自成立以来，专注于研发和制造立式包装机，灌装机，给袋式包装机，多列机和枕式机、理料线包装设备，产品广泛用于休闲零食食品、食品保健品，宠物食品，日用化工用品，果蔬生鲜，酱料和粉剂等行业，致力为企业客户定制和提供整体包装解决方案。

产品已获多个国家技术专利证书，并通过ISO9001质量管理体系认证，获欧盟CE, TUV, SGS, FDA认证。产品远销海外一百多个国家和地区，受到企业客户广泛好评和认可。

揽德人将持续深耕和优化产品，为客户提供高效、稳定、安全、包装美观的智能包装设备，并力求超越，让世界因揽德包装而更美好。



Development History of LandPack

揽德发展历程

2017-2018

Established 成立

LANDPACK brand was established, independently developed and manufactured vertical machines and pillow machines, obtained ISO9001 quality management system certification, EU CE, TUV, SGS, FDA certification, and its products were exported to more than 60 countries and regions, and has been widely praised and recognized by corporate customers.

LANDPACK揽德品牌建立，自主研发生产制造立式机和枕式机，获ISO9001质量管理体系认证，欧盟CE, TUV, SGS, FDA认证，产品远销六十多个国家和地区，受到企业客户广泛好评和认可。

2019-2024

Expansion 壮大

The Landpack's factory has expanded to 10,000 square meters, establishing dedicated departments for premade pouch machines, multilane packaging machines, and filling machines, along with a supporting machining center. The team has grown with the addition of senior engineers, experienced installation and commissioning technicians, as well as marketing and after-sales professionals, bringing the workforce to 140 employees. Our sales team has actively promoted the LANDPACK brand by participating in major exhibitions in Germany, Thailand, and across China, including Shanghai and Qingdao. Drawing on deep expertise in packaging solutions for snacks, pet food, daily chemical products, health supplements, and pharmaceuticals, the company delivers over 180 customized full-line packaging solutions annually, achieving a turnover of 80 million RMB.

厂房规模扩大至一万平方米，建立给袋机产品部门，多列机产品部门和灌装机产品部门，并建立配套机加工中心，新增多名骨干工程，资深安装调试技术员，营销和售后技术人员，员工规模达140人，继销售团队参加海外德国展、泰国展，及国内上海、青岛等多个展会进行品牌营销。结合公司团队深耕积累休闲零食食品，宠物食品，日用化工，保健品药品行业包装技术方案经验。一年为客户定制提供180多个整线包装方案，公司营业额达8000万。

2025-NOW

Development 发展

After thorough preparation, the company officially relocated from its 10,000m² old factory to a new 30,000m² modern plant. The expanded space accommodates more production lines and R&D areas, not only meeting the growing demand for capacity but also providing employees with an enhanced working environment. This relocation marks more than a physical upgrade—it represents a new milestone for high-quality development, empowering LANDPACK to serve customers with stronger capabilities and move forward with greater momentum.

历经筹备，公司正式从1万方旧厂房，乔迁至3万方新址！新厂房空间扩容，可承载更多生产线与研发区域，既解产能增长之需，也为员工提供更优环境。这不仅是物理空间的升级，更是公司迈向高质量发展的新起点，未来将以更强实力服务客户、聚力前行。





Technical strength 技术实力

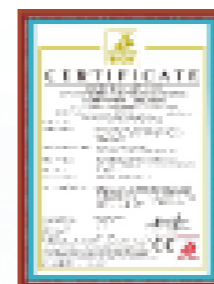

CE 认证

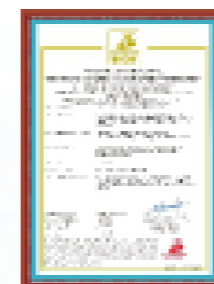

CE 认证

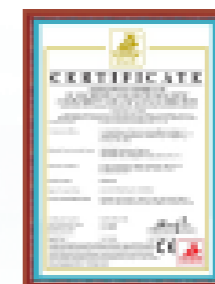

CE 认证

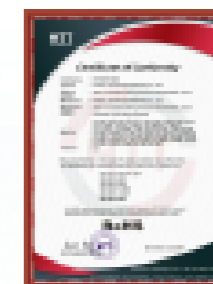

Rohs证书

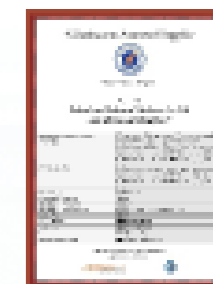

TUV 认证



ISO 认证

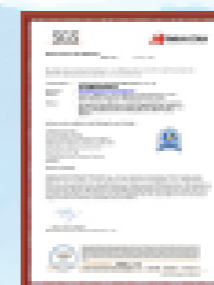

SGS 认证

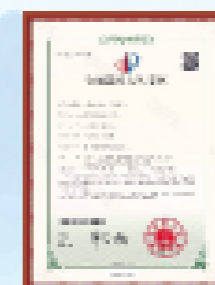

专利证书

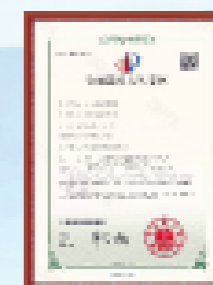

专利证书

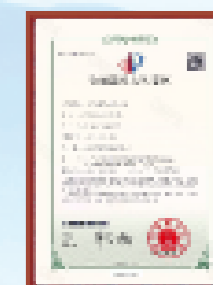

专利证书

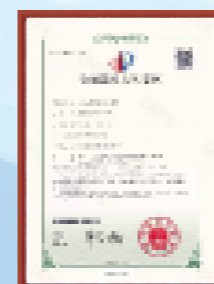

专利证书

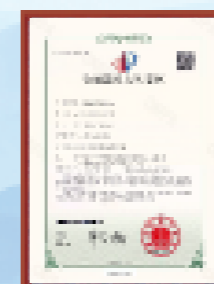

专利证书

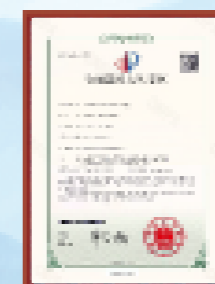

专利证书

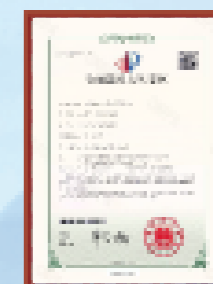

专利证书

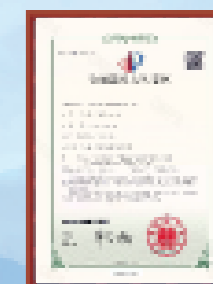

专利证书

Sales Marketing And Technical Services

营销和技术服务



200+
Industry packaging solution cases
every year

100%
After-sales technical service support



LandPack Exhibitions

揽德展会





目/录

CONTENTS >>>>

LP系列枕式包装机	Flow Packaging Machine	
(下走纸)枕式包装机	(Down Roll Film)Flow Packing Machine	P01
(上走纸)枕式包装机	(Upper Roll Film)Flow Packing Machine	P03
水果枕式包装机	Fruit Flow Packaging Machine	P05
蔬菜枕式包装机	Vegetable Flow Packaging Machine	P07
蔬菜枕式包装机+即时称重贴标机	Flow Packaging Machine+Real Time Weighing Labeling Machine	P09
往复式枕式包装机	Recipocating Flow Packing Machine	P11
面包枕式包装机	Bread Flow Packing Machine	P13
五金枕式包装机	Hardware Flow Packing Machine	P15
四合一全自动包装机(纸巾/筷子/牙签/勺子)	Disposale Cutlery Automatic Packing Machine	P17
医用配件枕式包装机	Medical Accessory Sleeves Flow Packaging Machine	P19
卧式四边封包装机	Four Side Sealing Packaging Machine	P21
热收缩膜包装机	Shrink Wrapper Machine	P23
高速巧克力饼干包装线	High Speed Chocolate Biscuit Packing Line	P25
高速夹心饼干包装线	High Speed Sandwich Biscuits Packing Line	P27
无托盒饼干包装机	Tray-Free Biscuit Packing Machine	P29
翻板自动理料线	Flapping Packing Line	P31
圆盘自动理料线	Rotary Disc Packing Line	P32
汉堡自动理料线	Hamburger Packing Line	P33

(Down Roll Film)Flow Packing Machine (下走纸)枕式包装机

LP-450X/LP-600X/LP-700X/LP-800X/LP-900X/LP-1000X

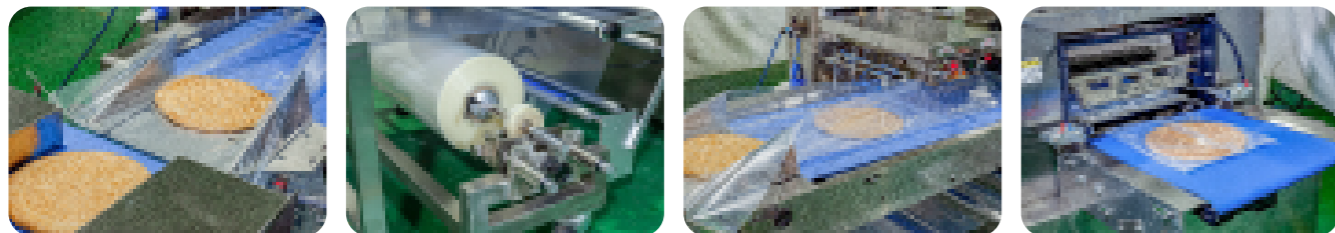

(一) 应用范围

- 披萨, 大饼, 毛巾, 纸巾, 挂面, 蛋卷, 香肠, 冰棒, 软糖, 饼干, 鲜果等柔软状, 长条状, 散装物的包装。

(二) 主要性能和结构特点

- 三伺服控制, 袋长即设即切, 无需调节空走, 一步到位, 省时省膜。
- 人机界面, 参数设定方便快捷。
- 故障自诊功能, 故障显示一目了然。
- 高敏感度光电眼色标跟踪, 数字化输入封切位置, 使封切位置更加准确。
- 温度独立PID控制, 更适合各种包装材质。
- 定位停机功能, 不粘刀, 不浪费包装膜。
- 传动系统简洁, 工作更可靠, 维护保养更方便。
- 所有控制由软件实现, 方便功能调整和技术升级, 永不落后。

Application scope

- Pizza, flatbread, towel, paper towel, noodles, egg rolls, sausage, popsicle, soft candy, biscuits, fresh fruit and other soft, long and bulk packaging.

Main performance and structural features

- Three servo control, bag length is set and cut immediately, no need to adjust the empty run, one-step, saving time and film.
- Human-machine interface, convenient and fast parameter setting.
- Fault self-diagnosis function, fault display is clear at a glance.
- High-sensitivity photoelectric eye color mark tracking, digital input sealing and cutting position, making the sealing and cutting position more accurate.
- Temperature independent PID control, better suitable for various packaging materials.
- Positioning stop function, no sticking knife, no waste of packaging film.
- The transmission system is simple, the operation is more reliable, and the maintenance is more convenient.
- All controls are implemented by software, which is convenient for function adjustment and technology upgrade, and never lags behind.

(三) 选配装置

- 皮带送料机构
- 端封拖链机构
- 辅助送料机构
- 防切料装置
- 打孔装置
- 插角机构
- 打码机
- 贴标机
- 热转印打码机
- 充气装置
- 切料停机
- 防空包
- 包装计数

Optional devices for pillow type machine

- Belt feeding mechanism
- End seal drag chain mechanism
- Auxiliary feeding mechanism
- Anti-cutting device
- Punching device
- Angle insertion mechanism
- Coding machine
- Labeling machine
- Thermal transfer coding machine
- Inflating device
- Cutting stop
- Anti-empty bag
- Packing counting

(四) 技术规格/Specifications

型号(Model)	LP-450X	LP-600X	LP-700X	LP-800X	LP-900X	LP-1000X
薄膜宽度(Film width)	Max.450mm	Max.600mm	Max.700mm	Max.800mm	Max.900mm	Max.1000mm
制袋长度(Bag length)	150-450mm	160-500mm	180-600mm	210-650mm	240-700mm	No limited
制袋宽度(Bag width)	50-180mm	100-280mm	100-330mm	120-350mm	150-400mm	300-450mm
产品高度(Product height)	Max.80mm	Max.110mm	Max.110mm	Max.130mm	Max.150mm	Max.200mm
卷膜直径(Film roll diameter)	Max.320mm	Max.320mm	Max.320mm	Max.320mm	Max.320mm	Max.320mm
包装速度(Packaging rate)	40-150 bags/min	20-150 bags/min	20-130 bags/min	20-120 bags/min	20-100 bags/min	15-25 bag/minute
电源规格(Power)	220V.50/60Hz,2.8kw	220V.50/60Hz,2.8kw	220V.50/60Hz,2.8kw	220V.50/60Hz,4.5kw	220V.50/60Hz,4.5kw	220V.50/60Hz,4.5kw
机器尺寸(Machine size)	4150*820*1450mm(L*W*H)	4300*920*1460mm(L*W*H)	4380*980*1480mm(L*W*H)	4100*1170*1550mm(L*W*H)	4300*1270*1550mm(L*W*H)	5300*1680*2100mm(L*W*H)
机器重量(Machine Weight)	About 650Kg	About 680Kg	About 720Kg	About 800Kg	About 850Kg	About 900Kg
备注(Remarks)	可加充气装置(optional air filling device)/插角装置(optional angle folding)					
包装材质(Film material)	OPP、PE、PVC、OPP/CPP、PT/PE、KOP/CPP镀铝膜、铝膜					

(五) 包装样品展示/Packaging samples show



(Upper Roll Film)Flow Packing Machine (上走纸)枕式包装机

LP-350B/LP-450B/LP-600B/LP-700B/LP-800B/LP-900B

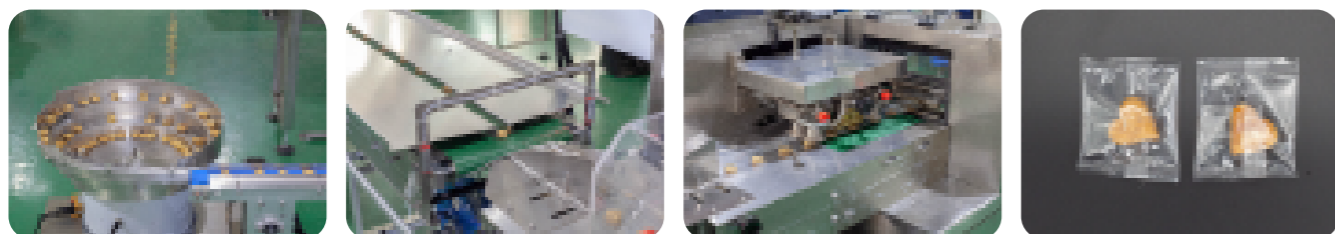

(一) 应用范围

- 宠物食品, 毛巾, 纸巾, 挂面, 蛋卷, 香肠, 冰棒, 软糖, 饼干, 鲜果等柔软状, 长条状, 散装物的包装。

(二) 主要性能和结构特点

- 三伺服控制, 袋长即设即切, 无需调节空走, 一步到位, 省时省膜。
- 人机界面, 参数设定方便快捷。
- 故障自诊功能, 故障显示一目了然。
- 高灵敏度光电眼色标跟踪, 数字化输入封切位置, 使封切位置更加准确。
- 温度独立PID控制, 更好适合各种包装材质。
- 定位停机功能, 不粘刀, 不浪费包装膜。
- 传动系统简洁, 工作更可靠, 维护保养更方便。
- 所有控制由软件实现, 方便功能调整和技术升级, 永不落后。

Application scope

- Packaging various kinds of regular objects like pet food, biscuits, pieschocolates, bread, instant, noodles, moon-cakes, drugs, daily, applications, industrial parts, paper boxes, tray, etc.

Main performance and structural features

- Three servo control, bag length is set and cut immediately, no need to adjust the empty run, one-step, saving time and film.
- Human-machine interface, convenient and fast parameter setting.
- Fault self-diagnosis function, fault display is clear at a glance.
- High-sensitivity photoelectric eye color mark tracking, digital input sealing and cutting position, making the sealing and cutting position more accurate.
- Temperature independent PID control, better suitable for various packaging materials.
- Positioning stop function, no sticking knife, no waste of packaging film.
- The transmission system is simple, the operation is more reliable, and the maintenance is more convenient.
- All controls are implemented by software, which is convenient for function adjustment and technology upgrade, and never lags behind.

(三) 选配装置

- 皮带送料机构
- 端封拖链机构
- 辅助送料机构
- 防切料装置
- 打孔装置
- 插角机构
- 打码机
- 贴标机
- 热转印打码机
- 充气装置
- 切料停机
- 防空包
- 包装计数

Optional devices for pillow type machine

- Belt feeding mechanism
- End seal drag chain mechanism
- Auxiliary feeding mechanism
- Anti-cutting device
- Punching device
- Angle insertion mechanism
- Coding machine
- Labeling machine
- Thermal transfer coding machine
- Inflating device
- Cutting stop
- Anti-empty bag
- Packing counting

(四) 技术规格/Specifications

型号(Model)	LP-350B	LP-450B	LP-600B	LP-700B	LP-800B	LP-900B
薄膜宽度(Film width)	Max.350mm	Max.450mm	Max.600mm	Max.700mm	Max.800mm	Max.900mm
制袋长度(Bag length)	90-400mm	150-450mm	160-500 mm	180-600mm	210-650mm	240-700mm
制袋宽度(Bag width)	50-160mm	50-180mm	100-280 mm	100-330mm	120-350mm	150-400mm
产品高度(Product height)	Max.40mm	Max.75mm	Max.110mm	Max.110mm	Max.130mm	Max.150mm
卷膜直径(Film roll diameter)	Max.320mm	Max.320mm	Max.320mm	Max.320mm	Max.320mm	Max.320mm
包装速度(Packaging rate)	40-180 bags/min	30-150 bags/min	20-150 bags/min	20-130 bags/min	20-120 bags/min	20-100 bag/minute
电源规格(Power)	220V.50/60Hz,2.6kw	220V.50/60Hz,2.8kw	220V.50/60Hz,2.8kw	220V.50/60Hz,2.8kw	220V.50/60Hz,4.5kw	220V.50/60Hz,4.5kw
机器尺寸(Machine size)	4030*770*1420mm(L*W*H)	4030*820*1420mm(L*W*H)	4030*970*1500mm(L*W*H)	4030*980*1500mm(L*W*H)	4100*1170*1550mm(L*W*H)	4300*1270*1550mm(L*W*H)
机器重量(Machine Weight)	About 580Kg	About 650Kg	About 680Kg	About 720Kg	About 800Kg	About 850Kg
备注(Remarks)	可加充气装置(optional air filling device)/插角装置(optional angle folding)					
包装材质(Film material)	OPP、PE、PVC、OPP/CPP、PT/PE、KOP/CPP镀铝膜、铝膜					

(五) 包装样品展示/Packaging samples show



Fruit Flow Packaging Machine

水果枕式包装机

LP-350G



(一) 应用范围

- 适用于橙子, 奇异果, 苹果, 火龙果, 土豆等单独包装的蔬菜水果。

(二) 主要性能和结构特点

- 三伺服控制, 袋长即设即切, 无需调节空走, 一步到位, 省时省膜。
- 人机界面, 参数设定方便快捷。
- 故障自诊功能, 故障显示一目了然。
- 高灵敏度光电眼色标跟踪, 数字化输入封切位置, 使封切位置更加准确。
- 温度独立PID控制, 更适合各种包装材质。
- 定位停机功能, 不粘刀, 不浪费包装膜。
- 传动系统简洁, 工作更可靠, 维护保养更方便。
- 所有控制由软件实现, 方便功能调整和技术升级, 永不落后。

Application scope

- It is suitable for orange, kiwi fruit, apple, pitaya, potato and other individually packaged vegetables and fruits, etc.

Main performance and structural features

- Three servo control, bag length is set and cut immediately, no need to adjust the empty run, one-step, saving time and film.
- Human-machine interface, convenient and fast parameter setting.
- Fault self-diagnosis function, fault display is clear at a glance.
- High-sensitivity photoelectric eye color mark tracking, digital input sealing and cutting position, making the sealing and cutting position more accurate.
- Temperature independent PID control, better suitable for various packaging materials.
- Positioning stop function, no sticking knife, no waste of packaging film.
- The transmission system is simple, the operation is more reliable, and the maintenance is more convenient.
- All controls are implemented by software, which is convenient for function adjustment and technology upgrade, and never lags behind.

(三) 选配装置

- 皮带送料机构
- 端封拖链机构
- 辅助送料机构
- 防切料装置
- 打孔装置
- 插角机构
- 打码机
- 贴标机
- 热转印打码机
- 充气装置
- 切料停机
- 防空包
- 包装计数

Optional devices for pillow type machine

- Belt feeding mechanism
- End seal drag chain mechanism
- Auxiliary feeding mechanism
- Anti-cutting device
- Punching device
- Angle insertion mechanism
- Coding machine
- Labeling machine
- Thermal transfer coding machine
- Inflating device
- Cutting stop
- Anti-empty bag
- Packing counting

(四) 技术规格/Specifications

型号(Model)	LP-350G
薄膜宽度(Film width)	Max.350mm
制袋长度(Bag length)	150-330mm
制袋宽度(Bag width)	50-160mm
产品高度(Product height)	Max.60mm
卷膜直径(Film roll diameter)	Max.320mm
包装速度(Packaging rate)	80-150 bags/min
电源规格(Power)	220V.50/60Hz,2.6kw
机器尺寸(Machine size)	4030*770*1420mm(L*W*H)
机器重量(Machine Weight)	About 580Kg
备注(Remarks)	可加充气装置(optional air filling device)/插角装置(optional angle folding)
包装材质(Film material)	OPP、PE、PVC、OPP/PP、PT/PE、KOP/PP镀铝膜、铝膜

(五) 包装样品展示/Packaging samples show



Vegetable Flow Packaging Machine

蔬菜枕式包装机

LP-450X/LP-600X/LP-700X/LP-800X/LP-900X



(一) 应用范围

- 菜叶类蔬菜, 胡萝卜, 玉米, 番薯, 香蕉等果蔬类包装。

(二) 主要性能和结构特点

- 三伺服控制, 袋长即设即切, 无需调节空走, 一步到位, 省时省膜。
- 人机界面, 参数设定方便快捷。
- 故障自诊功能, 故障显示一目了然。
- 高灵敏度光电眼色标跟踪, 数字化输入封切位置, 使封切位置更加准确。
- 温度独立PID控制, 更适合各种包装材质。
- 定位停机功能, 不粘刀, 不浪费包装膜。
- 传动系统简洁, 工作更可靠, 维护保养更方便。
- 所有控制由软件实现, 方便功能调整和技术升级, 永不落后。

Application scope

- Packaging various kinds of leaves vegetable, corns, carrots, banana, etc.

Main performance and structural features

- Three servo control, bag length is set and cut immediately, no need to adjust the empty run, one-step, saving time and film.
- Human-machine interface, convenient and fast parameter setting.
- Fault self-diagnosis function, fault display is clear at a glance.
- High-sensitivity photoelectric eye color mark tracking, digital input sealing and cutting position, making the sealing and cutting position more accurate.
- Temperature independent PID control, better suitable for various packaging materials.
- Positioning stop function, no sticking knife, no waste of packaging film.
- The transmission system is simple, the operation is more reliable, and the maintenance is more convenient.
- All controls are implemented by software, which is convenient for function adjustment and technology upgrade, and never lags behind.

(三) 选配装置

- 皮带送料机构
- 端封拖链机构
- 辅助送料机构
- 防切料装置
- 打孔装置
- 插角机构
- 打码机
- 贴标机
- 热转印打码机
- 充气装置
- 切料停机
- 防空包
- 包装计数

Optional devices for pillow type machine

- Belt feeding mechanism
- End seal drag chain mechanism
- Auxiliary feeding mechanism
- Anti-cutting device
- Punching device
- Angle insertion mechanism
- Coding machine
- Labeling machine
- Thermal transfer coding machine
- Inflating device
- Cutting stop
- Anti-empty bag
- Packing counting

(四) 技术规格/Specifications

型号(Model)	LP-450X	LP-600X	LP-700X	LP-800X	LP-900X	LP-100X
薄膜宽度(Film width)	Max.450mm	Max.600mm	Max.700mm	Max.800mm	Max.900mm	Max.1000mm
制袋长度(Bag length)	150-450mm	160-500mm	180-600mm	210-650mm	240-700mm	No limited
制袋宽度(Bag width)	50-180mm	100-280mm	100-330mm	120-350mm	150-400mm	300-450mm
产品高度(Product height)	Max.80mm	Max.110mm	Max.110mm	Max.130mm	Max.150mm	Max.200mm
卷膜直径(Film roll diameter)	Max.320mm	Max.320mm	Max.320mm	Max.320mm	Max.320mm	Max.320mm
包装速度(Packaging rate)	40-150 bags/min	20-150 bags/min	20-130 bags/min	20-120 bags/min	20-100 bags/min	15-25 bag/minute
电源规格(Power)	220V.50/60Hz,2.8kw	220V.50/60Hz,2.8kw	220V.50/60Hz,2.8kw	220V.50/60Hz,4.5kw	220V.50/60Hz,4.5kw	220V.50/60Hz,4.5kw
机器尺寸(Machine size)	4150*820*1450mm(L*W*H)	4300*920*1460mm(L*W*H)	4380*980*1480mm(L*W*H)	4100*1170*1550mm(L*W*H)	4300*1270*1550mm(L*W*H)	5300*1680*2100mm(L*W*H)
机器重量(Machine Weight)	About 650Kg	About 680Kg	About 720Kg	About 800Kg	About 850Kg	About 900Kg
备注(Remarks)	可加充气装置(optional air filling device)/插角装置(optional angle folding)					
包装材质(Film material)	OPP、PE、PVC、OPP/CPP、PT/PE、KOP/CPP镀铝膜、铝膜					

(五) 包装样品展示/Packaging samples show



Flow Packaging Machine+Real Time Weighing Labeling Machine 蔬菜枕式包装机+即时称重贴标机

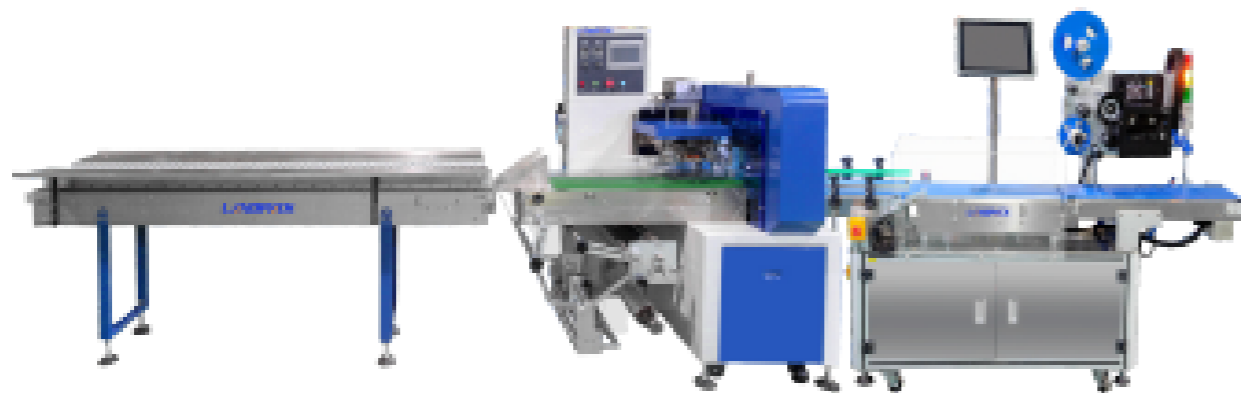

(一) 应用范围

- 适用于在各种物品的包装,可同时称重和贴标,如肉类、蔬菜、水果、饼干等包装,并即时称重和打印贴标、超市称重打印自动贴价格等。

(二) 主要性能和结构特点

- 三伺服控制,袋长即设即切,无需调节空走,一步到位,省时省膜。
- 机器自动根据产品的长度调节封切的距离,实现不定长切的功能。
- 人机界面,参数设定方便快捷。
- 故障自诊功能,故障显示一目了然。
- 高敏感度光电眼色标跟踪,数字化输入封切位置,使封切位置更加准确。
- 微软10系统,触摸屏,操作更便捷。
- 配称重系统,在原有的实时打印贴标机的基础上增加了自动称重的功能。完成输出数据实时打印贴标。
- 选配打印机品牌-TSC打印,打印清晰,性能稳定。

Application scope

- It is applicable to the packaging of various articles. It can weigh and label at the same time, such as the packaging of meat, vegetables, fruits and biscuits, weigh and print labels immediately, weigh and print prices automatically in supermarkets, etc.

Main performance and structural features

- Three servo motor control, Bag length can be set and cut in one step, saving time and film.
- The machine can seal bag based on the products length changing automatically.
- Interface features easy and quick setting and operation.
- Self failure diagnosis, clear failure display.
- High sensitivity photoelectric eye color tracing, numerical input of cutting sealing position for extra accuracy.
- Microsoft WINDOWS 10 system, touch screen, more convenient operation.
- Equipped with a weighing system, an automatic weighing function is added on the basis of the original real-time printing and labeling machine. Finish output data real-time printing and labeling.
- Optional printer brand-TSC printing, clear printing and stable performance; Imported photoelectric, more accurate detection.

(三) 选配装置

- 皮带送料机构
- 端封拖链机构
- 辅助送料机构
- 防切料装置
- 打孔装置
- 插角机构
- 打码机
- 贴标机
- 热转印打码机
- 充气装置
- 切料停机
- 防空包
- 包装计数

Optional devices for pillow type machine

- Belt feeding mechanism
- End seal drag chain mechanism
- Auxiliary feeding mechanism
- Anti-cutting device
- Punching device
- Angle insertion mechanism
- Coding machine
- Labeling machine
- Thermal transfer coding machine
- Inflating device
- Cutting stop
- Anti-empty bag
- Packing counting

(四) 技术规格/Specifications

型号(Model)	枕式包装/Flow packaging machine	型号(Model)	即时称重贴标机/Real Time Weighing Labeling Machine
薄膜宽度(Film width)	Max.450mm	贴标速度(Labeling speed)	20pcs /minute
制袋长度(Bag length)	150-450mm	称量范围(Weighing range)	3g-5000g
制袋宽度(Bag width)	50-180mm	适用标签尺寸(Labeling size)	L120mm W100mm
产品高度(Product height)	Max.80mm	台面尺寸(Platform size)	L700mm W300mm
卷膜直径(Film roll diameter)	Max.320mm	称重段(Weighing section)	L700mm W300mm
包装速度(Packaging rate)	40-150 bags/min	被测尺寸(Applicable product Size)	L500mm W280mm
电源规格(Power)	220V.50/60Hz,2.8kw	使用气源(Air source)	4-6 KG;30L/min
机器尺寸(Machine size)	4150*820*1450mm(L*W*H)	机器尺寸(Machine size)	2000*800*1600mm(L*W*H)
机器重量(Machine Weight)	About 650Kg	机器质量(Machine quality)	About150kg
包装材质(Film material)	OPP、PE、PVC、OPP/CPP、PT/PE、KOP/CPP	适用电压(Voltage)	800W/220V/50HZ

(五) 包装样品展示/Packaging samples show



Reciprocating Flow Packing Machine

往复式枕式包装机

LP-450W/LP-600W

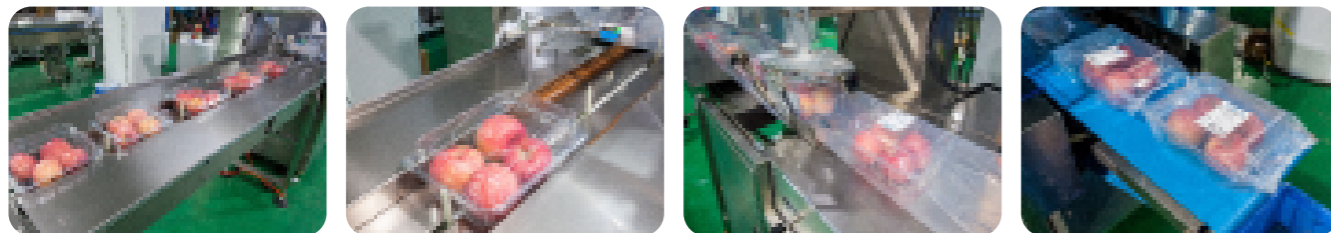

(一) 应用范围

- 适合于蔬菜瓜果、饼干、米通、雪饼、面包、方便面、米粉、纸巾、卫生巾、工业零件、纸盒或托盘等有规则物体带插角的大包装。

(二) 主要性能和结构特点

- 三伺服控制，袋长即设即切，无需调节空走，一步到位，省时省膜。
- 人机界面，参数设定方便快捷。
- 故障自诊功能，故障显示一目了然。
- 高敏感度光电眼色标跟踪，数字化输入封切位置，使封切位置更加准确。
- 温度独立PID控制，更适合各种包装材质。
- 定位停机功能，不粘刀，不浪费包装膜。
- 传动系统简洁，工作更可靠，维护保养更方便。
- 所有控制由软件实现，方便功能调整和技术升级，永不落后。

Application scope

- Suitable for packaging regular objects such as biscuits, pies, bread, instant noodles, drugs daily appliances, industrial parts, paper boxes, plates, etc.

Main performance and structural features

- Three servo control, bag length is set and cut immediately, no need to adjust the empty run, one-step, saving time and film.
- Human-machine interface, convenient and fast parameter setting.
- Fault self-diagnosis function, fault display is clear at a glance.
- High-sensitivity photoelectric eye color mark tracking, digital input sealing and cutting position, making the sealing and cutting position more accurate.
- Temperature independent PID control, better suitable for various packaging materials.
- Positioning stop function, no sticking knife, no waste of packaging film.
- The transmission system is simple, the operation is more reliable, and the maintenance is more convenient.
- All controls are implemented by software, which is convenient for function adjustment and technology upgrade, and never lags behind.

(三) 选配装置

- 皮带送料机构
- 端封拖链机构
- 辅助送料机构
- 防切料装置
- 打孔装置
- 插角机构
- 打码机
- 贴标机
- 热转印打码机
- 充气装置
- 切料停机
- 防空包
- 包装计数

Optional devices for pillow type machine

- Belt feeding mechanism
- End seal drag chain mechanism
- Auxiliary feeding mechanism
- Anti-cutting device
- Punching device
- Angle insertion mechanism
- Coding machine
- Labeling machine
- Thermal transfer coding machine
- Inflating device
- Cutting stop
- Anti-empty bag
- Packing counting

(四) 技术规格/Specifications

型号(Model)	LP-450W	LP-600W
薄膜宽度(Film width)	Max.450mm	Max.600mm
制袋长度(Bag length)	120-450mm	120-450mm
制袋宽度(Bag width)	50-160mm	50-200mm
产品高度(Product height)	10-80mm	10-80mm
卷膜直径(Film roll diameter)	Max.320mm	Max.320mm
包装速度(Packaging rate)	20-80 bags/min	20-80 bags/min
电源规格(Power)	220V.50/60Hz,3.2kw	220V.50/60Hz,3.6kw
机器尺寸(Machine size)	4380*870*1500mm(L*W*H)	3990*970*1500mm(L*W*H)
机器重量(Machine Weight)	About 950Kg	About 1160Kg
备注(Remarks)	可加充气装置(optional air filling device)/插角装置(optional angle folding)	
包装材质(Film material)	OPP、PE、PVC、OPP/CPP、PT/PE、KOP/CPP镀铝膜、铝膜	

(五) 包装样品展示/Packaging samples show



Bread Flow Packing Machine

面包枕式包装机

LP-600B



(一) 应用范围

- 适合于面包, 方便面, 月饼, 蔬菜瓜果, 药品, 日用品, 工业零件, 纸盒或托盘等各类有规则物体的包装。

(二) 主要性能和结构特点

- 三伺服控制, 袋长即设即切, 无需调节空走, 一步到位, 省时省膜。
- 人机界面, 参数设定方便快捷。
- 故障自诊功能, 故障显示一目了然。
- 高灵敏度光电眼色标跟踪, 数字化输入封切位置, 使封切位置更加准确。
- 温度独立PID控制, 更适合各种包装材质。
- 定位停机功能, 不粘刀, 不浪费包装膜。
- 传动系统简洁, 工作更可靠, 维护保养更方便。
- 所有控制由软件实现, 方便功能调整和技术升级, 永不落后。

Application scope

- Packaging various kinds of regular objects like biscuits, bread, instant, noodles, moon-cakes, drugs, daily applications, industrial parts, paper boxes, tray, etc.

Main performance and structural features

- Three servo control, bag length is set and cut immediately, no need to adjust the empty run, one-step, saving time and film.
- Human-machine interface, convenient and fast parameter setting.
- Fault self-diagnosis function, fault display is clear at a glance.
- High-sensitivity photoelectric eye color mark tracking, digital input sealing and cutting position, making the sealing and cutting position more accurate.
- Temperature independent PID control, better suitable for various packaging materials.
- Positioning stop function, no sticking knife, no waste of packaging film.
- The transmission system is simple, the operation is more reliable, and the maintenance is more convenient.
- All controls are implemented by software, which is convenient for function adjustment and technology upgrade, and never lags behind.

(三) 选配装置

- 皮带送料机构
- 端封拖链机构
- 辅助送料机构
- 防切料装置
- 打孔装置
- 插角机构
- 打码机
- 贴标机
- 热转印打码机
- 充气装置
- 切料停机
- 防空包
- 包装计数

Optional devices for pillow type machine

- Belt feeding mechanism
- End seal drag chain mechanism
- Auxiliary feeding mechanism
- Anti-cutting device
- Punching device
- Angle insertion mechanism
- Coding machine
- Labeling machine
- Thermal transfer coding machine
- Inflating device
- Cutting stop
- Anti-empty bag
- Packing counting

(四) 技术规格/Specifications

型号(Model)	LP-600B
薄膜宽度(Film width)	Max.680mm
制袋长度(Bag length)	150-560mm
制袋宽度(Bag width)	100-260mm
产品高度(Product height)	Max.110mm
卷膜直径(Film roll diameter)	Max.320mm
包装速度(Packaging rate)	30-150 bags/min
电源规格(Power)	220V.50/60Hz,6kw
机器尺寸(Machine size)	4800*1200*1700mm(L*W*H)
机器重量(Machine Weight)	About 1120Kg
包装材质(Film material)	OPP、PE、PVC、OPP/CPP、PT/PE、KOP/CPP镀铝膜、铝膜

(五) 包装样品展示/Packaging samples show



Hardware Flow Packing Machine 五金枕式包装机

LP-350X/450X/LP-600X/LP-700X/LP-800X/LP-900X

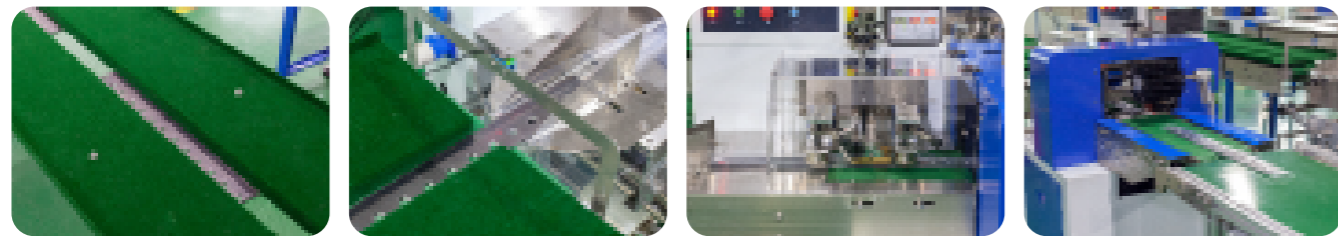

(一) 应用范围

- 适用于切刀, 灯座盖, 插座等包装。

(二) 主要性能和结构特点

- 三伺服控制, 袋长即设即切, 无需调节空走, 一步到位, 省时省膜。
- 人机界面, 参数设定方便快捷。
- 故障自诊功能, 故障显示一目了然。
- 高灵敏度光电眼色标跟踪, 数字化输入封切位置, 使封切位置更加准确。
- 温度独立PID控制, 更适合各种包装材质。
- 定位停机功能, 不粘刀, 不浪费包装膜。
- 传动系统简洁, 工作更可靠, 维护保养更方便。
- 所有控制由软件实现, 方便功能调整和技术升级, 永不落后。

Application scope

- Suitable for packaging of cutters, lamp holder covers, sockets, etc.

Main performance and structural features

- Three servo control, bag length is set and cut immediately, no need to adjust the empty run, one-step, saving time and film.
- Human-machine interface, convenient and fast parameter setting.
- Fault self-diagnosis function, fault display is clear at a glance.
- High-sensitivity photoelectric eye color mark tracking, digital input sealing and cutting position, making the sealing and cutting position more accurate.
- Temperature independent PID control, better suitable for various packaging materials.
- Positioning stop function, no sticking knife, no waste of packaging film.
- The transmission system is simple, the operation is more reliable, and the maintenance is more convenient.
- All controls are implemented by software, which is convenient for function adjustment and technology upgrade, and never lags behind.

(三) 选配装置

- 皮带送料机构
- 端封拖链机构
- 辅助送料机构
- 防切料装置
- 打孔装置
- 插角机构
- 打码机
- 贴标机
- 热转印打码机
- 充气装置
- 切料停机
- 防空包
- 包装计数

Optional devices for pillow type machine

- Belt feeding mechanism
- End seal drag chain mechanism
- Auxiliary feeding mechanism
- Anti-cutting device
- Punching device
- Angle insertion mechanism
- Coding machine
- Labeling machine
- Thermal transfer coding machine
- Inflating device
- Cutting stop
- Anti-empty bag
- Packing counting

(四) 技术规格/Specifications

型号(Model)	LP-350X	LP-450X	LP-600X	LP-700X	LP-800X	LP-900X
薄膜宽度(Film width)	Max.350mm	Max.450mm	Max.600mm	Max.700mm	Max.800mm	Max.900mm
制袋长度(Bag length)	120-280mm	150-450mm	160-500mm	180-600mm	210-650mm	240-700mm
制袋宽度(Bag width)	50-160mm	50-180mm	100-280mm	100-330mm	120-350mm	150-400mm
产品高度(Product height)	Max.40mm	Max.80mm	Max.110mm	Max.110mm	Max.130mm	Max.150mm
卷膜直径(Film roll diameter)	Max.320mm	Max.320mm	Max.320mm	Max.320mm	Max.320mm	Max.320mm
包装速度(Packaging rate)	40-180 bags/min	40-150 bags/min	20-150 bags/min	20-130 bags/min	20-120 bags/min	20-100 bags/min
电源规格(Power)	220V.50/60Hz,2.6kw	220V.50/60Hz,2.8kw	220V.50/60Hz,2.8kw	220V.50/60Hz,2.8kw	220V.50/60Hz,4.5kw	220V.50/60Hz,4.5kw
机器尺寸(Machine size)	4030*770*1420mm(L*W*H)	4150*820*1450mm(L*W*H)	4300*920*1460mm(L*W*H)	4380*980*1480mm(L*W*H)	4100*1170*1550mm(L*W*H)	4300*1270*1550mm(L*W*H)
机器重量(Machine Weight)	About 580Kg	About 650Kg	About 680Kg	About 720Kg	About 800Kg	About 850Kg
备注(Remarks)	可加充气装置(optional air filling device)/插角装置(optional angle folding)					
包装材质(Film material)	OPP、PE、PVC、OPP/CPP、PT/PE、KOP/CPP镀铝膜、铝膜					

(五) 包装样品展示/Packaging samples show



Disposable Cutlery Automatic Packing Machine

四合一全自动包装机(纸巾/筷子/牙签/勺子)

LP-350X



(一) 应用范围

- 适用于:单片湿巾(纸巾)筷子,牙签包装,纸巾筷子勺子包装,纸巾刀叉勺航空餐具包装等各类有规则的物体包装。

(二) 主要性能和结构特点

- 机械配方功能(储存已调试好的程序),避免多次包装同类规格产品反复调试,浪费材料,节约更多时间成本,提高包装效率。
- 湿巾折叠机和包装机可以单独运行(随时可以单独关闭湿巾机或者包装机)。
- 采用高品质双变频简约机械结构,易维护、磨损少、寿命长。
- 高精度光电检测跟踪(膜色标跟踪),双向自动补偿,精确可靠。
- 袋长可无需人工设定,设备运行中自动检测、自动设定。
- 包装速度和成袋长度采用双变频器控制,无极变速,任意调节范围宽,可以与生产线的前道工序完美匹配。

Application scope

- Be applied to: single wet tissue, chopsticks, toothpick, and all kinds of regularly products, etc.

Main performance and structural features

- Mechanical formula function(reserving have been debugged procedure), avoid that muliple packaging similar specification products may make it debugging repeatedly, wasting material , saving more time to improve packing efficiency.
- Wet tissue folding machinery and packaging machinery can isolated operation (Both of one is closing ,another one also can running any time).
- Wet tissue folding machinery and packaging machinery can isolated operation(both of one is closing, another one also can running any time).
- High-precision photoelectric detection tracking,bi-directional automatic compensation, accurate and reliable.
- Bag length without manual configuration ,auto-detection equipment operation ,automatically set.
- Packing speed and bag length of the dual inverter control, stepless variable speed , arbitrary adjustment range , with the former working procedure of production line a perfect match.

(三) 选配装置

- 包装效率高,性能稳定,操作维护方便,故障率低。
- 可长时间连续运转。
- 密封性能好,包装效果美观。
- 并可同步打印生产日期、穿悬挂孔等设备。(根据顾客需要定做)
- 纸巾折叠机采用伺服电机控制,精确度高,调节方便。

Optional devices for pillow type machine

- High efficiency-packing , steady performance , convenient operation and maintenance , low-rate fault.
- It can work continuously for a long time.
- Sealing well , good-looking appearance
- Printing production date synchronize with hanging hole.(according to the customers requirement)
- Tissue folding machine use servo motor , accurately and adjustable.

(四) 技术规格/Specifications

型号(Model)	LP-350X	LP-450X
包装宽度(Packing width)	30-100mm	30-100mm
包装高度(Packing height)	≤40mm	≤40mm
包装厚度(Packing film thickness)	0.03mm (0.03-0.08mm)	0.03mm (0.03-0.08mm)
制袋长度(Bag length)	90-330mm	90-330mm
纸巾长度(Tissue length)	120-330mm	120-330mm
最大薄膜厚度(Max film width)	230mm	230mm
最大包装能力(Maximum packing capacity)		
电压(Voltage)	240V/150 bag/min(视材料而定/depending on material)V	
总功率(Total power)	3.2kw	3.8kw
外观尺寸(Dimension(LxWxH))	5200x2080x2200mm	6200x2080x2200mm
机器重量(Overall weight)	720kg	950kg

(五) 包装样品展示/Packaging samples show



Medical Accessory Sleeves Flow Packaging Machine

医用配件枕式包装机

LP-700X

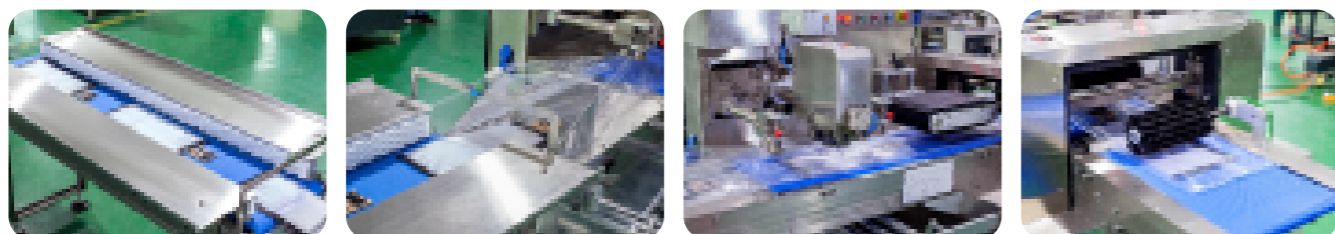

(一) 应用范围

- 适用于医用袖, 医用纱布, 一次性床单, 毛巾和浴巾等包装。

(二) 主要性能和结构特点

- 三伺服控制, 袋长即设即切, 无需调节空走, 一步到位, 省时省膜。
- 人机界面, 参数设定方便快捷。
- 故障自诊功能, 故障显示一目了然。
- 高灵敏度光电眼色标跟踪, 数字化输入封切位置, 使封切位置更加准确。
- 温度独立PID控制, 更适合各种包装材质。
- 定位停机功能, 不粘刀, 不浪费包装膜。
- 传动系统简洁, 工作更可靠, 维护保养更方便。
- 所有控制由软件实现, 方便功能调整和技术升级, 永不落后。

Application scope

- Suitable for packaging of medical cuffs, medical gauze, disposable sheets, towels and bath towels, etc.

Main performance and structural features

- Three servo control, bag length is set and cut immediately, no need to adjust the empty run, one-step, saving time and film.
- Human-machine interface, convenient and fast parameter setting.
- Fault self-diagnosis function, fault display is clear at a glance.
- High-sensitivity photoelectric eye color mark tracking, digital input sealing and cutting position, making the sealing and cutting position more accurate.
- Temperature independent PID control, better suitable for various packaging materials.
- Positioning stop function, no sticking knife, no waste of packaging film.
- The transmission system is simple, the operation is more reliable, and the maintenance is more convenient.
- All controls are implemented by software, which is convenient for function adjustment and technology upgrade, and never lags behind.

(三) 选配装置

- 皮带送料机构
- 端封拖链机构
- 辅助送料机构
- 防切料装置
- 打孔装置
- 插角机构
- 打码机
- 贴标机
- 热转印打码机
- 充气装置
- 切料停机
- 防空包
- 包装计数

Optional devices for pillow type machine

- Belt feeding mechanism
- End seal drag chain mechanism
- Auxiliary feeding mechanism
- Anti-cutting device
- Punching device
- Angle insertion mechanism
- Coding machine
- Labeling machine
- Thermal transfer coding machine
- Inflating device
- Cutting stop
- Anti-empty bag
- Packing counting

(四) 技术规格/Specifications

型号(Model)	LP-700X
薄膜宽度(Film width)	Max.700mm
制袋长度(Bag length)	180-600 mm
制袋宽度(Bag width)	100-330 mm
产品高度(Product height)	Max.110mm
卷膜直径(Film roll diameter)	Max.320mm
包装速度(Packaging rate)	20-130 bags/min
电源规格(Power)	220V.50/60Hz,2.8kw
机器尺寸(Machine size)	4380*980*1480mm(L*W*H)
机器重量(Machine Weight)	About 720Kg
包装材质(Film material)	OPP、PE、PVC、OPP/CPP、PT/PE、KOP/CPP镀铝膜、铝膜

(五) 包装样品展示/Packaging samples show



Four Side Sealing Packaging Machine

卧式四边封包装机

LPF-350

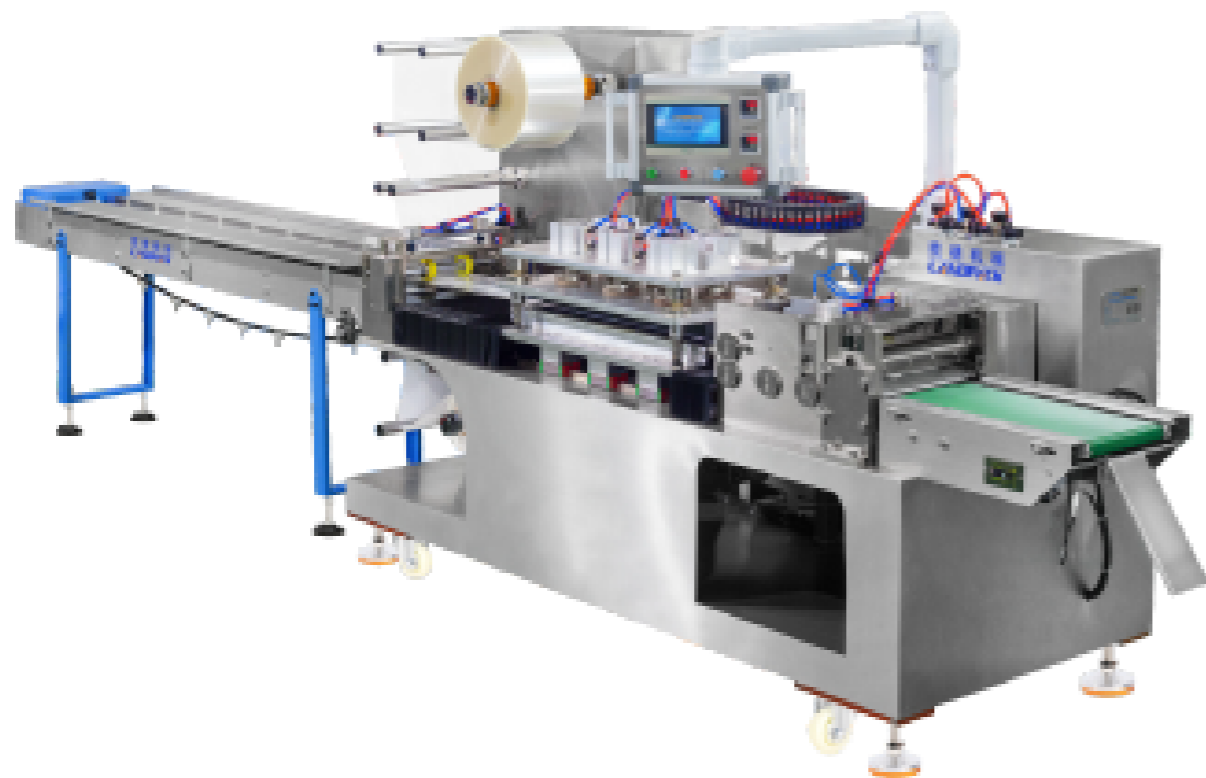

(一) 应用范围

- 适用于口罩, 酒店用品, 卡片, 膏药贴等日化包装。

(二) 主要性能和结构特点

- 彩色触摸屏操作界面, 操作简单; 采用科学的四轴伺服驱动系统; PLC可编程控制器智能控制整机运行, 具有送膜精准、物料输送稳定、切袋精准等优点。
- 创新设计: 独立导柱模座, 移动式同步热封系统, 封口温度更均匀稳定, 封边严密, 经久耐用! 不同厚度、不同材质的包装材料适应性更强。
- 医疗袋型: 四边封, 末端易撕开; 纸+透明薄膜袋。
- 多功能性: 本机也适用于一种包装材料的包装袋。该机可根据产品长度的变化自动封袋。

Application scope

- Suitable to pack masks, hotel supplies, cards, plasters, etc.

Main performance and structural features

- The color touch screen operation interface is simple to operate; the scientific 4-axis servo drive system is adopted; the PLC programmable controller intelligently controls the operation of the whole machine, which has the advantages of precise film feeding, stable material transfer, and precise bag cutting.
- Innovative design: independent guide pillar mold base, mobile synchronous heat sealing system, the temperature of the sealing surface is more uniform and stable, the sealing edge is tight, and it is durable! . Packaging materials of different thicknesses and materials are more adaptable.
- Medical bag type: Four-side sealing bag, easy to tear opening at the end; paper + transparent film bag.
- Versatility: This machine is also suitable for use in packaging bags of one type of packaging material. The machine can seal bag base on the products length changing automatically.

(三) 选配装置

- 打挂孔
- 打码机
- 一卷膜分切结构
- 两卷膜封合结构
- V型易撕口
- 冲圆角
- 单通道, 双通道, 三通道可选

Optional devices for pillow type machine

- Hanging hole puncher
- Date printer
- One roll of film slitting structure
- Two rolls of film sealing structure
- V shape easy tear
- Round angle
- Single-lane, Two-lane, Three-lane feeding as choices

(四) 技术规格/Specifications

型号(Model)	LPF-350
薄膜宽度(Film width)	Max.350mm
制袋长度(Bag length)	70-500mm
制袋宽度(Bag width)	70-150mm
产品包装厚度(Product packaging thickness)	1-10mm
机器噪音(Machine noise)	< 80db(A)
卷膜直径(Max diameter of roll film)	Max.320mm
包装材质(Packing material)	ET+OPP, BOPP, CPP, PET+AL, 单层或双层加热复合膜/and other one layer or double layer heated complex film
包装速度(Packing speed)	4487*1270*1170mm(L*W*H)
机器尺寸(Machine size)	About 1600kg
机器毛重(Machine Gross Weight)	AC220V 50HZ
电压(Power voltage)	4.2kw
加热功率(Heating Power)	3.2kw
气压(Air Pressure)	0.5-0.7Mpa
应用(Application)	口罩, 酒店用品, 卡片, 膏药贴等日化包装/masks, hotel supplies, cards, plasters and so on

(五) 包装样品展示/Packaging samples show



Shrink Wrapper Machine

热收缩膜包装机

LPF-590

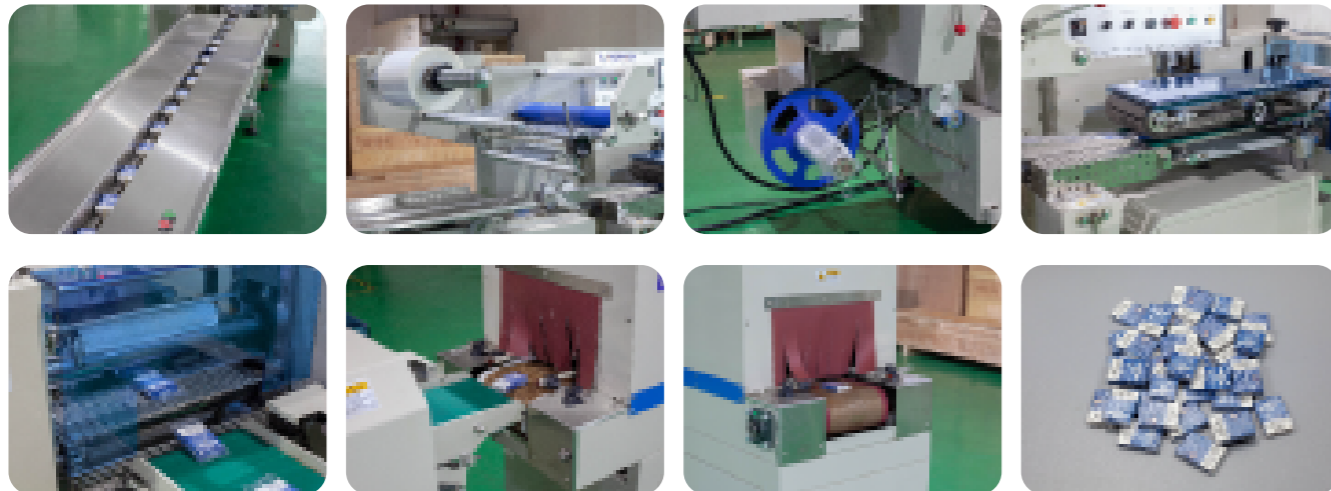

(一) 应用范围

- 广泛用于日用品、洗发水、口香糖盒、书本、一次性餐具、纸盒等包装。

(二) 主要性能和结构特点

- 产品预设数可记忆保持100种产品规格,生产时输入产品号即可以最快捷地进入生产状态节约调试工作量。
- 自动控温,PLC控制,三伺服控制,可快速更换包装物,高高度电眼自动追踪,设定后无需手动调整,封切尺寸和位置准确,封口牢固美观。
- 封切刀经特种合金材料喷涂铁氟龙处理,不粘膜。
- 滚筒外包耐高温硅胶管可自由转动,不锈钢加热管,内部三层隔热,大功率循环风机,双向热循环风使热量均匀,恒温。

Application scope

- Widely used in packaging of daily necessities, shampoos, gum boxes, books, disposable tableware, Carton boxes, etc.

Main performance and structural features

- The preset number of products can be memorized to maintain 100 product specifications. Enter the product number during production to enter the production state most quickly and save debugging workload.
- Automatic temperature control, PLC control, three-servo control, can quickly change the packaging, high-altitude electric eye automatic tracking, no need to manually adjust after setting, the sealing and cutting size and position are accurate, and the sealing is firm and beautiful.
- The sealing and cutting knife is treated with special alloy material sprayed with Teflon, and it does not stick to the film.
- The drum outside the high temperature resistant silicone tube can rotate freely, stainless steel heating tube, internal three-layer heat insulation, high-power circulating fan, two-way hot circulating air to make the heat even and constant temperature.

(三) 选配装置

- 皮带送料机构
- 端封拖链机构
- 辅助送料机构
- 防切料装置
- 打孔装置
- 插角机构
- 打码机
- 贴标机
- 热转印打码机
- 充气装置
- 切料停机
- 防空包
- 包装计数

Optional devices for pillow type machine

- Belt feeding mechanism
- End seal drag chain mechanism
- Auxiliary feeding mechanism
- Anti-cutting device
- Punching device
- Angle insertion mechanism
- Coding machine
- Labeling machine
- Thermal transfer coding machine
- Inflating device
- Cutting stop
- Anti-empty bag
- Packing counting

(四) 技术规格/Specifications

型号(Model)	LP-590 (Flow packing machine)
包装速度(Packaging rate)	5-120 5-120 pcs/minute
包装尺寸(Product dimension)	L:60-280 / W:60-200 H:30-100
电压(Power voltage)	220/380V/50HZ
总功率(Total Power)	约5.5kw
机器尺寸(Machine size)	2700*1000*1680mm(L*W*H)
机器重量(Machine Weight)	800kg

型号(Model)	LP-240 (Shrink wrapper)
包装速度(Packaging rate)	220/380V/50HZ
包装尺寸(Product dimension)	约15kw
电压(Power voltage)	220/380V/50HZ
总功率(Total Power)	2400*710*1400mm(L*W*H)
机器尺寸(Machine size)	400kg
机器重量(Machine Weight)	POF PE PVC PP

(五) 包装样品展示/Packaging samples show



High Speed Chocolate Biscuit Packing Line 高速巧克力饼干包装线



(一) 应用范围

- 适用于巧克力, 饼干, 曲奇, 坚果棒等方形, 长方形, 圆形的固体物块的包装。

(二) 主要性能和结构特点

- 定制化高速包装机, 包装能力为 500-600 件/分钟。
- 先进技术配置防切料, 防空包, 无料停止放膜, 节省包材。
- 横封、纵封、送料均采用独立伺服电机控制, 机械结构简洁, 运行平稳。
- 菜单储存记忆功能, 能够保存多组参数配置, 只需选择菜单里的配方即可。
- 独立PID温度控制, 适应各种包装卷膜材质。
- 人机界面, 故障自诊断功能, 故障一目了然。

Application scope

- Suitable for packaging square, rectangular, round solid objects such as chocolate, biscuits, cookies, nut bars, etc.

Main performance and structural features

- Customized high-speed packaging machines with a packaging capacity of 500-600 pcs/minute.
- Advanced technology configuration, anti-cutting material, anti-empty packaging, stop film release when there is no material, save packaging materials.
- Horizontal sealing, vertical sealing and feeding are all controlled by independent servo motors, with simple mechanical structure and stable operation.
- Menu storage memory function, can save multiple sets of parameter configurations, just select the recipe in the menu.
- Independent PID temperature control, suitable for various packaging film materials.
- Human-machine interface, fault self-diagnosis function, faults are clear at a glance.

(三) 选配装置

- 对多理料皮带
- 防切料装置
- 防空包装装置
- 收纳机构
- 金检/重检剔除装置
- 切料停机
- 热转印打码机
- 打码机
- 打孔装置
- 多语言界面操作

Optional devices for pillow type machine

- Multiple material sorting belt
- Anti-cutting device
- Anti-empty bag device
- Storage mechanism
- Metal inspection/re-inspection rejection device
- Cutting stop
- Thermal transfer coding machine
- Coding machine
- Punching device
- Multi-language interface operation

(四) 技术规格/Specifications

型号(Model)	LP-500
薄膜宽度(Film width)	65-280mm
制袋长度(Bag length)	85-230mm
制袋宽度(Bag width)	20-90mm
产品高度(Product height)	5-40mm
卷膜直径(Film roll diameter)	Max.320mm
包装速度(Packaging rate)	35-400 bags/min
电源规格(Power)	220V,50/60Hz,4.5kw
机器尺寸(Machine size)	4000*770*1600mm(L*W*H)
机器重量(Machine Weight)	750kg
包装材质(Film material)	OPP/PP, PT/PE, KOP/PP/ALU FOIL

(五) 包装样品展示/Packaging samples show



High Speed Sandwich Biscuits Packing Line 高速夹心饼干包装线

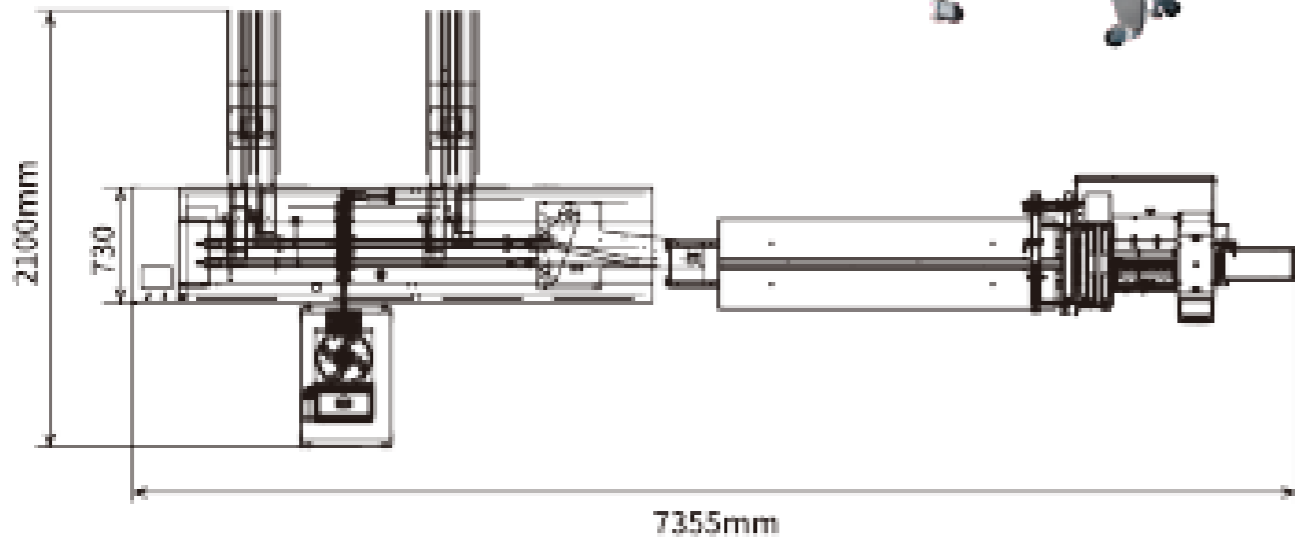

(一) 应用范围

- 适用于饼干, 曲奇等方形、长方形、圆形的固体物块的包装。

(二) 主要性能和结构特点

- 定制化高速包装机, 包装能力为 500-600 件/分钟。
- 先进技术配置防切料, 防空包, 无料停止放膜, 节省包材。
- 横封、纵封、送料均采用独立伺服电机控制, 机械结构简洁, 运行平稳。
- 菜单储存记忆功能, 能够保存多组参数配置, 只需选择菜单里的配方即可。
- 独立PID温度控制, 适应各种包装卷膜材质。
- 人机界面, 故障自诊断功能, 故障一目了然。

Application scope

- Suitable for packaging biscuits, cookies, and other square, rectangular, and round solid objects, etc.

Main performance and structural features

- Customized high-speed packaging machines with a packaging capacity of 500-600 pcs/minute.
- Advanced technology configuration, anti-cutting material, anti-empty packaging, stop film release when there is no material, save packaging materials.
- Horizontal sealing, vertical sealing and feeding are all controlled by independent servo motors, with simple mechanical structure and stable operation.
- Menu storage memory function, can save multiple sets of parameter configurations, just select the recipe in the menu.
- Independent PID temperature control, suitable for various packaging film materials.
- Human-machine interface, fault self-diagnosis function, faults are clear at a glance.

(三) 技术规格/Specifications

型号 (MODEL)	200-1400枚/分钟 (sandwiches/min.)
产量 (Capacity)	4.5KW,220V/50HZ
电源 (Power supply)	1000KGS
重量 (G.weight)	双排单色或者双色夹心 (single or double flavorcream filling)
应用范围 (Application)	圆形 (Round) : Φ35-65mm
夹心饼范围 (Biscuit range)	长方形 (Rectangle) : 长 (L) 35-65mm, 宽 (W) 35-65mm

型号 (Model)	LP-600	LP-700
薄膜宽度 (Film width)	65-280mm	65-280mm
制袋长度 (Bag length)	62-250mm	90-300mm
制袋宽度 (Bag width)	35-80mm	35-160mm
产品高度 (Product height)	5-35mm	5-40mm
卷膜直径 (Film roll diameter)	Max.320mm	Max.320mm
包装速度 (Packaging rate)	60-250 bags/min	60-300 bags/min
电源规格 (Power)	220V,50/60Hz,3.8kw	220V,50/60Hz, 6.5kw
机器尺寸 (Machine size)	4000*770*1600mm(L*W*H)	4000*770*1600mm(L*W*H)
机器重量 (Machine Weight)	350kg	450kg
包装材质 (Film material)	OPP/CPP, PT/PE, KOP/CPP/ALU FOIL	OPP/CPP, PT/PE, KOP/CPP/ALU FOIL

(三) 工作示意图/Work schematic diagram

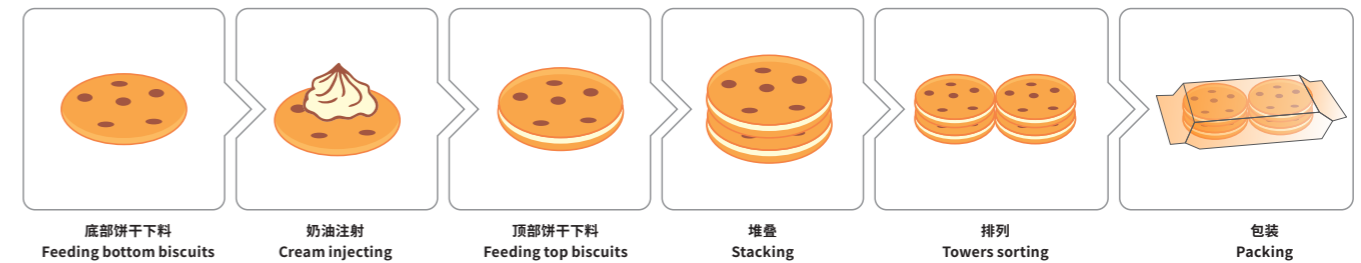

(五) 包装样品展示/Packaging samples show



Tray-Free Biscuit Packing Machine

无托盒饼干包装机



(一) 应用范围

- 适用于饼干, 曲奇等方形、长方形、圆形的固体物块的包装。

(二) 主要性能和结构特点

- 定制化高速包装机, 包装能力为 500-600 件/分钟。
- 先进技术配置防切料, 防空包, 无料停止放膜, 节省包材。
- 横封、纵封、送料均采用独立伺服电机控制, 机械结构简洁, 运行平稳。
- 菜单储存记忆功能, 能够保存多组参数配置, 只需选择菜单里的配方即可。
- 独立PID温度控制, 适应各种包装卷膜材质。
- 人机界面, 故障自诊断功能, 故障一目了然。



Application scope

- Suitable for packaging biscuits, cookies, and other square, rectangular, and round solid objects, etc.

Main performance and structural features

- Customized high-speed packaging machines with a packaging capacity of 500-600 pcs/minute.
- Advanced technology configuration, anti-cutting material, anti-empty packaging, stop film release when there is no material, save packaging materials.
- Horizontal sealing, vertical sealing and feeding are all controlled by independent servo motors, with simple mechanical structure and stable operation.
- Menu storage memory function, can save multiple sets of parameter configurations, just select the recipe in the menu.
- Independent PID temperature control, suitable for various packaging film materials.
- Human-machine interface, fault self-diagnosis function, faults are clear at a glance.

(三) 选配装置

- 对多理料皮带
- 防切料装置
- 防空包装装置
- 收纳机构
- 金检/重检剔除装置
- 切料停机
- 热转印打码机
- 打码机
- 打孔装置
- 多语言界面操作

Optional devices for pillow type machine

- Multiple material sorting belt
- Anti-cutting device
- Anti-empty bag device
- Storage mechanism
- Metal inspection/re-inspection rejection device
- Cutting stop
- Thermal transfer coding machine
- Coding machine
- Punching device
- Multi-language interface operation

(四) 技术规格/Specifications

型号(Model)	LP-800
薄膜宽度(Film width)	65-500mm
制袋长度(Bag length)	80-250mm
制袋宽度(Bag width)	30-100mm
产品高度(Product height)	5-40mm
卷膜直径(Film roll diameter)	Max.320mm
包装速度(Packaging rate)	35-120 bags/min
电源规格(Power)	220V,50/60Hz,10kw
机器尺寸(Machine size)	4000*930*1360mm(L*W*H)
机器重量(Machine Weight)	1400kg
包装材质(Film material)	OPP/CPP, PT/PE, KOP/CPP/ALU FOIL

(五) 包装样品展示/Packaging samples show



Hamburger Packing Line

汉堡自动理料线

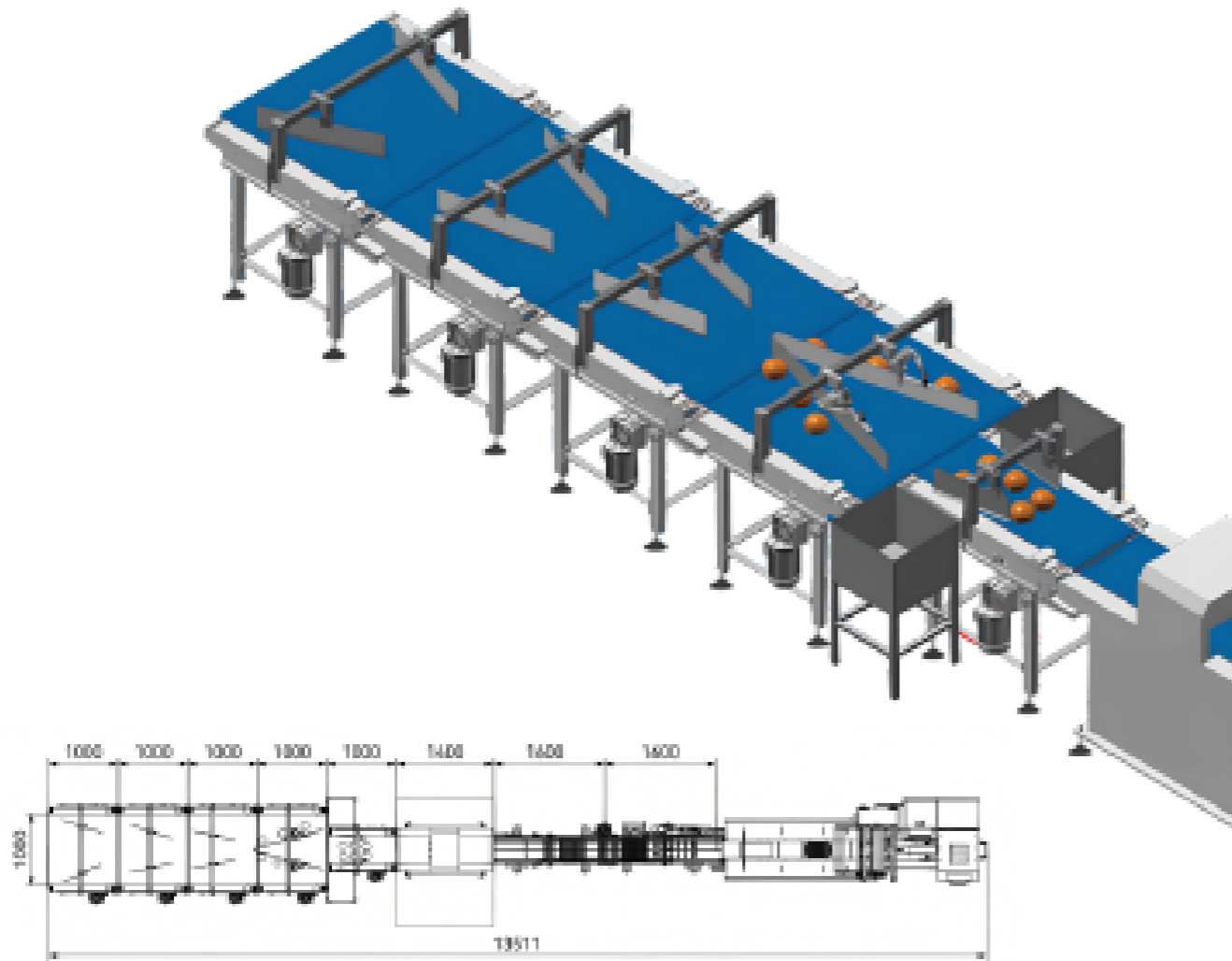

(一) 包装样品展示/Packaging samples show



(二) 应用范围

- 汉堡自动理料线主要适用于圆形面包多排多列的包装形式。前端可对接生产线实现自动连 也可人工上料。

(三) 设备优势

- 多排多列自动理料线输送平台配置产品均分装置,保证各通道产品数量均匀。
- 多段差速拉距整理,实现物料平稳输送,定位精准,高速稳定。

(四) 主要性能和结构特点

- 汉堡自动理料线由拉距输送机、理料机组以及自动包装机组成,对圆形面包等产品进行拉距和 均分整理。经过光电检测,控制理料机组和挡料机构,按设定数量排列组合,进入自动包装机 进行包装,达到生产连续、有序、废品率低、包装美观的效果。
- 单条线包装速度30-40包/分钟(根据产品组合方式有差异)。

Application scope

- The hamburger packing line is mainly suitable for the packing of round bread with multi-row multi-line. The front end can be connected to the production line to realize automatic continuous feeding or manual feeding, etc.

Equipment Advantages

- The conveyor platform of the hamburger packing line is equipped with a product equalization device to ensure that the number of products in each channel is even.
- Multi-segment differential speed pulling distance arrangement realizes stable material conveying, precise positioning, high speed stability.

Main performance and structural features

- The hamburger packing line is composed of a stretch conveyor, a sorting unit and an automatic packing machine, which stretches and evenly sorts round bread and other products. After photoelectric detection, control the sorting unit and the blocking mechanism, arrange and combine according to the set number, enter the automatic packing machine for packing, and achieve the effect of continuous, orderly production, low rejection rate and beautiful packing.
- The packing speed of a single line is 30-40 bags/min (different according to the product combination).

